

INSPIRED BY EFFICIENCY

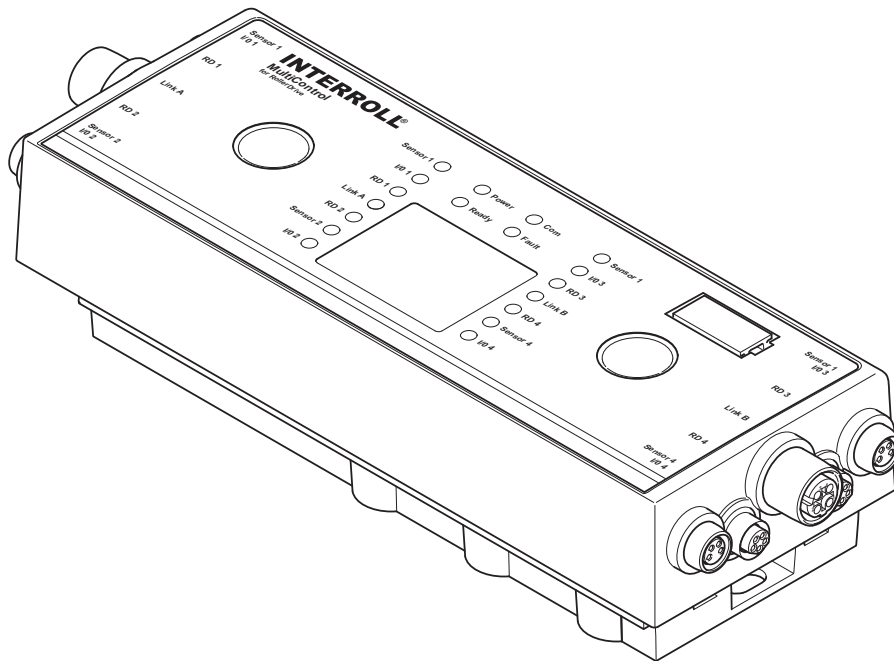

User Manual

Interroll MultiControl

Manufacturer's address

Interroll Engineering GmbH
Hoferhof 16
D-42929 Wermelskirchen
Ph. +49 2193 23 0
Fax. +49 2190 2022
www.interroll.com

Copyright

The copyright of this manual remains with Interroll Engineering GmbH. The operating instructions contain technical regulations and drawings which may not be reproduced partially or in full, transmitted by any means, utilized without permission for competitive purposes or disclosed to third parties.

Table of Contents

Introduction.....	6
Information about the manual.....	6
Contents	6
The manual is part of the product	6
Warning notices in this manual	6
Symbols.....	6
Safety	7
State of the art.....	7
Intended use	7
Personnel qualification	7
Operators	7
Service personnel	7
Electricians	7
Dangers.....	8
Bodily injury.....	8
Electricity	8
Working environment	8
Faults during operation.....	8
Maintenance	8
Accidental motor start.....	8
Interfaces to other devices.....	9
Operating modes	9
Normal mode.....	9
Special mode	9
Product information.....	10
Product description	10
Automatic configuration.....	10
Energy recovery / Overvoltage protection	10
Overload protection device	10
Structure	11
Scope of supply	12
Nameplate	12
Technical data	13
Dimensions.....	13
Transport and storage	14
Ambient conditions for transport and storage.....	14
Transport.....	14
Storage	14
Assembly and installation	15
Warning information for assembly.....	15
Assembly of MultiControl.....	15
Initial assembly.....	15
Repeated assembly	16
Warning notices concerning the electrical installation.....	17

Table of Contents

Electrical installation	18
Connect the power supply	18
Connecting the RollerDrive	19
Connecting the bus.....	20
Connecting the sensors	21
Initial startup and operation.....	22
Checks before initial startup.....	22
Configuration options	22
User interface.....	23
Service Data Objects (SDO).....	24
Magnetic sensor	25
Configuring MultiControl	27
Setting bus parameters.....	27
Selecting the application module	28
Configuring inputs and outputs.....	28
Defining the motor type.....	28
Switching off the LED indicators	28
Defining the error behavior.....	28
Resetting to factory settings.....	29
Reading out version information	29
Operation.....	30
Pre-startup checks.....	30
Start.....	30
Stop	30
Process data	31
Process image of the inputs	31
Process image of the outputs.....	33
Maintenance and cleaning.....	36
Warning notices concerning maintenance and cleaning.....	36
Maintenance	36
Checking MultiControl.....	36
Replacing MultiControl.....	36
Cleaning.....	36
Decommissioning and disposal	37
Shutdown.....	37
Disposal.....	37
Troubleshooting.....	38
Meaning of the LEDs	38
General LEDs	38
LEDs of connections.....	39
Troubleshooting.....	40
Error messages.....	40
Additional faults	41
Appendix	42
Accessories.....	42
Data types.....	42

Table of Contents

Cyclical process image.....	43
Input.....	43
Output	46
Acyclical data	48
Version information	48
Manufacturer information	48
Diagnostic information	48
Error information	49
Network online time.....	49
Control program information.....	49
Bus parameters.....	50
Motor settings.....	51
Inputs and outputs	52
LED indicators	53
Application module	53
Error behavior	54
I/O configuration.....	55
Error codes.....	56
Installation declaration.....	58

Introduction

Information about the manual

Contents This manual contains important notes and information about the various operating phases of the MultiControl.

The manual describes the MultiControl as it is delivered by Interroll.

In addition to this manual, special contractual agreements and technical documents apply to special versions.

The manual is part of the product

- ▶ For trouble-free, safe operation and warranty claims, read the manual first and follow the instructions.
- ▶ Keep the manual near to the MultiControl.
- ▶ Pass the manual on to any subsequent operator or occupant.
- ▶ **NOTICE! The manufacturer does not accept any liability for faults or defects due to non-observance of this manual.**
- ▶ If you have any questions after reading the operating instructions, please contact the Interroll customer service. Contact persons close to you can be found on the Internet under www.interroll.com/contacts.

Warning notices in this manual

The warning notices refer to risks which may arise while usage the MultiControl. They are available in four danger levels identified by the signal word:

Signal word	Meaning
DANGER	Identifies a danger with high risk that can lead to death or serious injury if it is not avoided.
WARNING	Identifies a danger with medium risk that can lead to death or serious injury if it is not avoided.
CAUTION!	Identifies a danger with low risk that can lead to minor or medium injury if it is not avoided.
NOTICE	Identifies a danger that can lead to property damages.

Symbols



This symbol marks useful and important information.

Requirement:

- This symbol represents a prerequisite to be met prior to assembly and maintenance work.
- ▶ This symbol marks the steps to be carried out.

Safety

State of the art

The MultiControl has been built to comply with the state of the art and is operationally safe in its delivered state. Nevertheless, users may encounter hazards during use:



Disregarding the notices in this manual may lead to serious injury.

- ▶ Carefully read the manual and follow its content.

Intended use

The MultiControl may only be used for industrial applications and in an industrial environment to control a RollerDrive EC310 or a VDC motor. A corresponding adapter must be used to connect a VDC motor.

The MultiControl must be integrated into a conveyor module or conveyor system. Any other use is considered inappropriate.

Any modifications that affect the safety of the product are not permitted.

The MultiControl may only be operated within the defined operating limits.

Deviating applications require the approval of Interroll.

Personnel qualification

Unqualified personnel cannot recognize risks and, as a result, is subject to greater dangers.

- ▶ Authorize only qualified personnel with the activities described in these operating instructions.
- ▶ The operating company must ensure that the personnel follows locally applicable regulations and rules during their work with regard to safety and dangers.

The following target groups are addressed in these operating instructions:

Operators	Operators have been instructed in the operation and cleaning of the MultiControl and follow the safety guidelines.
Service personnel	The service personnel features a technical training and performs the maintenance and repair tasks.
Electricians	Persons working on electrical installations must have the pertinent technical training.

Safety

Dangers



The following list provides information about the various types of danger or damage that may occur while working with the MultiControl.

Bodily injury

- ▶ Maintenance or repair work must only be performed by authorized and qualified persons according to the applicable regulations.
- ▶ Before using the MultiControl, ensure that no unauthorized persons are near the conveyor.

Electricity

- ▶ Only perform installation and maintenance work after you have switched off the power.
- ▶ Ensure that the power cannot be turned on accidentally.

Working environment

- ▶ Do not use the MultiControl in areas where there is a hazard of explosion.
- ▶ Remove material that is not required and unnecessary objects from the workspace.

Faults during operation

- ▶ Regularly inspect the MultiControl for visible damage.
- ▶ If you notice smoke, switch off the power immediately and ensure that it cannot be switched on again accidentally.
- ▶ Contact qualified personnel immediately to find the source of the fault.

Maintenance

- ▶ Because the product does not require maintenance, you only need to inspect the MultiControl regularly for visible damage and that all cables and screws are firmly in place.

Accidental motor start

- ▶ Ensure that a connected motor cannot start accidentally, particularly for assembly, maintenance work and troubleshooting.

Safety

Interfaces to other devices

By assembling the MultiControl in a conveyor module, potential hazards may occur. These are not part of this manual and have to be analyzed during the design, installation and startup of the complete system.

- ▶ After assembling the MultiControl in a conveyor module, check the whole system for a new potential dangerous spot before switching on the conveyor.
- ▶ Additional constructive measures may be required.

Operating modes

Normal mode Operation of the installed device at the end customer's as a component in a conveyor in a complete system.

Special mode Special operation refers to all operating modes which are required to guarantee and maintain regular operation.

Special operating mode	Explanation	Comment
Transport/Storage	Loading and unloading, transport and storage	-
Assembly/Initial start-up	Installation at the end customer and performing the test run	-
Cleaning	External cleaning without removing protective devices	When de-energized
Maintenance/Repairs	Maintenance and inspection tasks	When de-energized
Troubleshooting	Troubleshooting in the event of a fault	-
Fault elimination	Eliminating the fault	When de-energized
Shutdown	Removing from the complete system	When de-energized
Disposal	Removing from the complete system and disassembly	When de-energized

Product information

Product description

The MultiControl is a control for conveyor systems that can control up to four motors. At the same time, it is also a certified I/O device for PROFINET, EtherNet/IP and EtherCAT and, as such, can be networked with other MultiControls and a PLC.

Sensors and RollerDrives can be integrated directly into the fieldbus layer via the MultiControl. This allows saving a complete additional sensor/actuator layer.

The MultiControl can easily and flexibly be configured via a PLC programming environment, a web user interface or the Interroll Teach-In procedure. The procedure simplifies and shortens the startup time on site and also enables the simple exchange of a single MultiControl.

If a special conveyor logic is to be used, the MultiControl can be equipped with a special software by Interroll. As a result, it can be used as an individual control system – with or without connected PLC.

The MultiControl is compatible with all 24-V conveyor modules from Interroll Automation GmbH. So-called ZPA+ programs are used to operate the conveyor modules. These programs are described in a separate operating manual. The functions of the ZPA programs are also described in a separate operating manual.

Automatic configuration

To provide an easy startup of large conveyor systems with many zones, it is possible to automatically configure MultiControl. For this purpose, the fault signals or operational currents of the connected motors as well as the signals of at least two adjacent zone sensors are captured and analyzed and used to determine or specify the following settings:

- The number of motors connected to every MultiControl
- The number of zones per MultiControl
- The sensor configuration (PNP / NPN type and normally-open / normally-closed logic)
- The network address of every MultiControl
- A name assignment for every MultiControl
- The neighboring relations of the MultiControl
- Rotating direction of the motors for downstream transport

Energy recovery / Overvoltage protection

If the RollerDrive is braked or stopped, the kinetic energy of the RollerDrive (and a package being conveyed) will be converted into electrical energy. This energy is fed back into the system where it can be used by other RollerDrives.

If the energy recovery is higher than the energy demand the excess energy is converted into heat by a brake chopper integrated in the MultiControl. The brake chopper is activated when the voltage exceeds 26 V. As such, excessively high voltages within the system are avoided.

Overload protection device

If the brake chopper is activated for more than two seconds, it is switched off again since it is assumed in this case that the power supply delivers an incorrect voltage. If overload protection is active, this is shown on the LED display. As long as overload protection is active, the motors cannot be switched on.

Product information

Structure

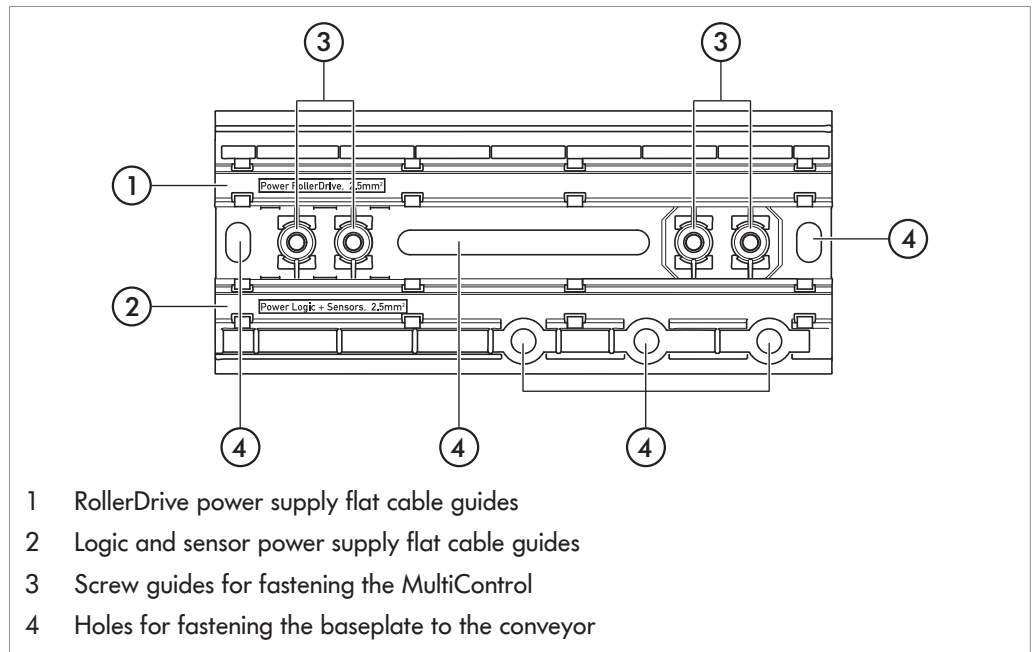
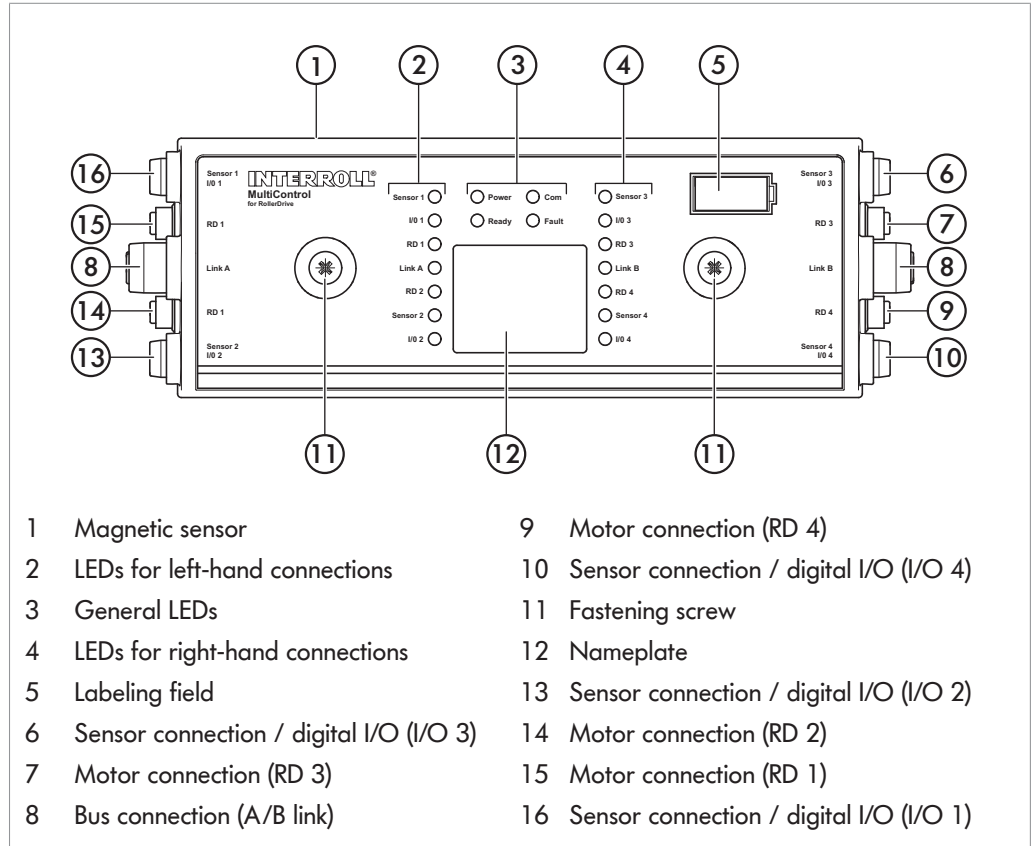

Product information

Scope of supply

The scope of supply of the MultiControl contains the following components:

- MultiControl
- Baseplate
- Two screws for fastening the MultiControl to the baseplate

Nameplate

The information on the nameplate is used to identify the MultiControl.

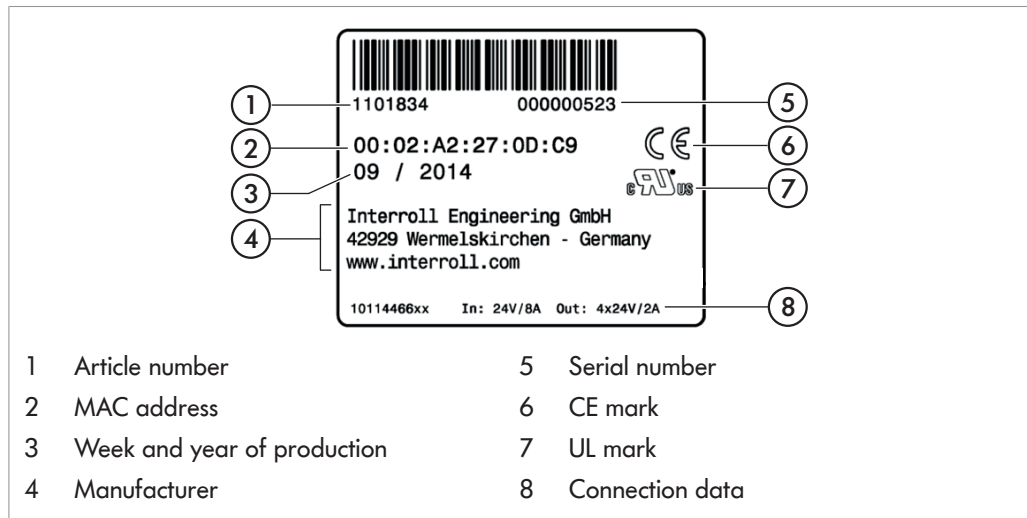

Product information

Technical data

	MultiControl
Rated voltage	24 V DC ($\pm 5\%$)
Voltage range	19 to 26 V DC
Current consumption	Logic + Sensors: 1.7 A RollerDrive rated current: $4 \times 2\text{ A} = 8\text{ A}$ RollerDrive max. startup current: $4 \times 4\text{ A} = 16\text{ A}$
Protection classification	IP54
Weight	500 g (incl. base plate)
Ambient temperature in operation	-30 °C to +40 °C (-22 °F to +104 °F)
Ambient temperature during transport and storage	-40 °C to +85 °C (-40 °F to +185 °F)
Temperature change	1 K/min, 3 h (two cycles in acc. with IEC 68-2-14)
Relative humidity	max. 93% at +40 °C (+104 °F), 14 days, non-condensing (IEC 68-2-78, DIN EN 60068-2-78)
Max. installation height above sea level	max. 1,000 m (max. 3,300 ft) The installation in systems at an altitude above 1,000 m (3,300 ft) is possible in principle. However, it may result in a reduction of the performance values.

Dimensions

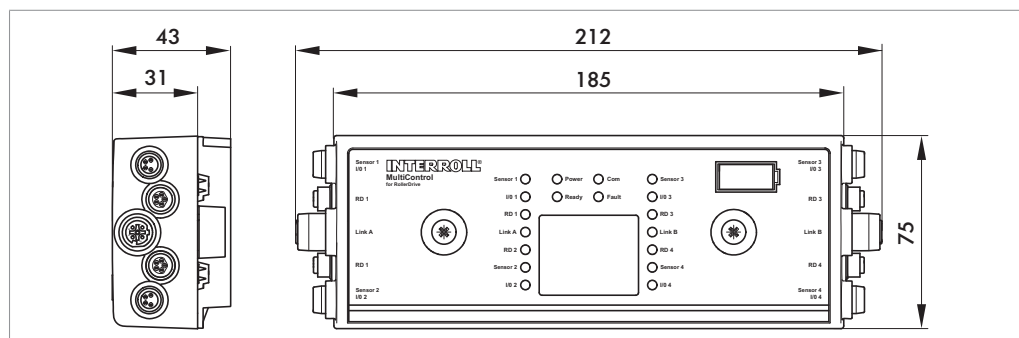

The distance from the top edge of the MultiControl to neighboring components must be at least 10 mm to be able to operate the magnetic sensor.

Transport and storage

Ambient conditions for transport and storage

Ambient temperature during transport and storage	-40 °C to +85 °C (-40 °F to +185 °F)
Temperature change	1 K/min, 3 h (two cycles in acc. with IEC 68-2-14)
Relative humidity	max. 93% at +40 °C (+104 °F), 14 days, non-condensing (IEC 68-2-78, DIN EN 60068-2-78)

Transport

- Every MultiControl is packaged in its own cardboard box.

⚠ CAUTION

Improper transport poses a hazard of injury.

- ▶ Transport-related tasks should only be carried out by qualified and authorized persons.
 - ▶ Follow the instructions below.
-
- ▶ Do not stack more than four cardboard boxes on top of each other.
 - ▶ Check that the MultiControl is correctly fixed in place prior to transport.
 - ▶ Avoid serious impacts during transport.
 - ▶ Inspect every MultiControl for visible damage and completeness (accessories) following transport.
 - ▶ In the event of damage, take photos of the damaged parts.
 - ▶ Report any damage caused by transport immediately to the transport company and Interroll to retain the right to claim for compensation.
 - ▶ Do not expose the MultiControl to serious temperature fluctuations as this could result in condensation.

Storage

NOTICE

Risk of damage to property due to improper storage

- ▶ Do not stack more than four cardboard boxes on top of each other.
-
- ▶ Check each MultiControl for damage after storage.

Assembly and installation

Warning information for assembly

NOTICE

Risk of damage leading to failure or shortened life expectancy

- ▶ Check each MultiControl visually for damage before assembly.
 - ▶ Make sure that the MultiControl is not warped during installation (no bending or torsion).
 - ▶ Do not drill additional mounting holes in the casing or baseplate or enlarge the holes provided.
 - ▶ Do not drop the MultiControl to prevent internal damage.
-

Assembly of MultiControl

Initial assembly

To fasten the MultiControl at the conveyor frame, the supplied baseplate must first be mounted on the conveyor frame. The baseplate features two sets of two holes for fastening the MultiControl. The left-hand holes should be used for initial assembly.



To simplify electrical installation, if possible all MultiControl should be assembled on the same side of the conveyor. In the case of curves, wherever possible the MultiControl should be assembled on the outside radius as the RollerDrive connection is on this side.



The distance from the top edge of the MultiControl to neighboring components must be at least 10 mm to be able to operate the magnetic sensor.

- ▶ Identify a flat area on the conveyor system frame on which the MultiControl can be assembled. Ensure that there is approx. 25 mm space to the left of the designated area in order to be able to move the MultiControl at a later date if necessary (See "*Repeated assembly*", page 16).
- ▶ Use the baseplate as a template and mark the center of both mounting holes. Pay attention to the correct orientation of the baseplate (the labeling in the cable duct must be readable).
- ▶ Drill two holes with a diameter of 6.5 mm on the markings in the conveyor frame.
- ▶ Screw the baseplate onto the conveyor using M6 screws.
- ▶ Ensure that the baseplate is not distorted.
- ▶ Insert flat cables for the voltage supply (See "*Connect the power supply*", page 18).

Assembly and installation

- ▶ Place the MultiControl onto the left hole in each case and push it down until the locking mechanism engages.

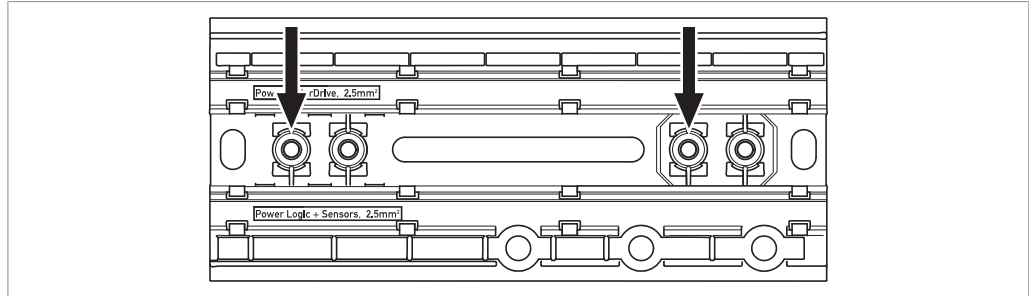

- ▶ Fasten the MultiControl with the available screws in MultiControl and a Phillips screwdriver onto the baseplate according to DIN EN ISO 4857-Z2. Maximum tightening torque 2 Nm. This drives the contact pins through the flat cable and establishes contact with the voltage supply.



To ensure a proper fastening of the MultiControl on the baseplate, only the screws supplied may be used. If they are being damaged or lost, they can be reordered from Ejot using article number 4280049809 (<http://www.ejot.com>).

Repeated assembly

If an already connected flat cable had to be removed from a MultiControl, the flat cable must not be pierced at the same point as otherwise a proper contact cannot be ensured. To avoid the flat cable having to be removed and repositioned on all MultiControl, in this case the MultiControl can be attached via the right-hand mounting hole in each case. Consequently, the position of the MultiControl to the flat cable changes and the flat cable can be pierced at a different point. The insulation is self-healing which means protection rating IP54 is achieved.

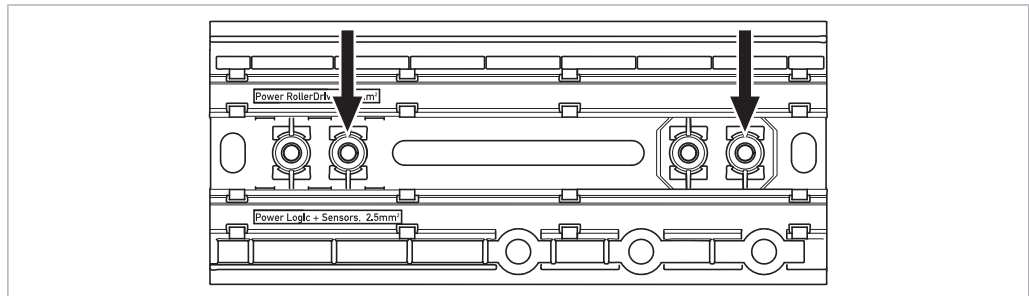

Warning notices concerning the electrical installation



Improper electrical installation can lead to damage of the MultiControl.

- ▶ Electrical work should only be performed by qualified and authorized persons.
- ▶ Disconnect the power supply before installing, removing or rewiring the MultiControl.
- ▶ Ensure that no hazardous voltage can come into contact with the connections or the housing, not even in the event of a malfunction or fault.
- ▶ Do not connect AC voltage to the RollerDrive or the MultiControl at any time, as this will cause irreparable damage to the device.
- ▶ Connect all power supplies used to a common ground potential to avoid compensating currents via the MultiControl or the bus line.
- ▶ Do not use ground connections or ground wires as a protective conductor (PE).
- ▶ Do not apply too much tension or load to the plug. The cable insulation can be damaged if the cable is bent at the plug and the MultiControl or the RollerDrive could fail.
- ▶ Ensure that existing electrical installations do not interfere with the MultiControl or the RollerDrive.
- ▶ Only use cables that are dimensioned sufficiently for the application.
- ▶ Ensure that the switching power supply unit supplying the MultiControl supplies a nominal DC voltage of 24 V with a maximum deviation of $\pm 5\%$.
- ▶ Ensure that the RollerDrives, the MultiControl and the voltage source are connected to the conveyor frame or supporting structure in such a way that they are properly grounded. Incorrect grounding can result in the build-up of static charge, causing the RollerDrive or MultiControl to malfunction or fail prematurely.
- ▶ Use suitable switching equipment to ensure safe operation.
- ▶ Only apply operating voltages when all of the cables have been connected.
- ▶ Do not forget to observe the calculations for voltage drop on electrical lines.
- ▶ Observe the regulations for routing cables.

Electrical installation

Connect the power supply

One or two flat cables of type 3G3G-FL with a core cross-section of $2 \times 2.5 \text{ mm}^2$ are used for the power supply:

- When using one flat cable, the MultiControl, the RollerDrives, the sensors and the logic are supplied by the same power source.
- If two flat cables are used, the sensors and the logic are supplied with separate voltage sources. This allows switching off the RollerDrives (e.g. in case of an Emergency Stop) without losing the bus communication.

The two ground potentials of the voltage supply are connected with each other in the MultiControl. The two positive contacts are connected with each other via a diode in the MultiControl. This ensures that the logic can be supplied via the RollerDrive line, but not the RollerDrive via the logic supply.

Laying the flat cable:

- ▶ Use only flat cables of type 3G3G-FL with a core cross-section of $2 \times 2.5 \text{ mm}^2$.
- ▶ Do not bundle the flat cable with other control cables or high-voltage lines. Laying system C or E according to DIN VDE 0298-4 is preferred.
- ▶ If a flat cable must be extended or the orientation be changed, use an Interroll cable bridge (See "Accessories", page 42).

Connecting the flat cable:

- ▶ Place the flat cable in its correct orientation without tension and without torsion in the cable duct on the baseplate. The cable ducts have a form-fit design (see graphic). As such, the flat cable can only be laid in one direction and polarity cannot be reversed.

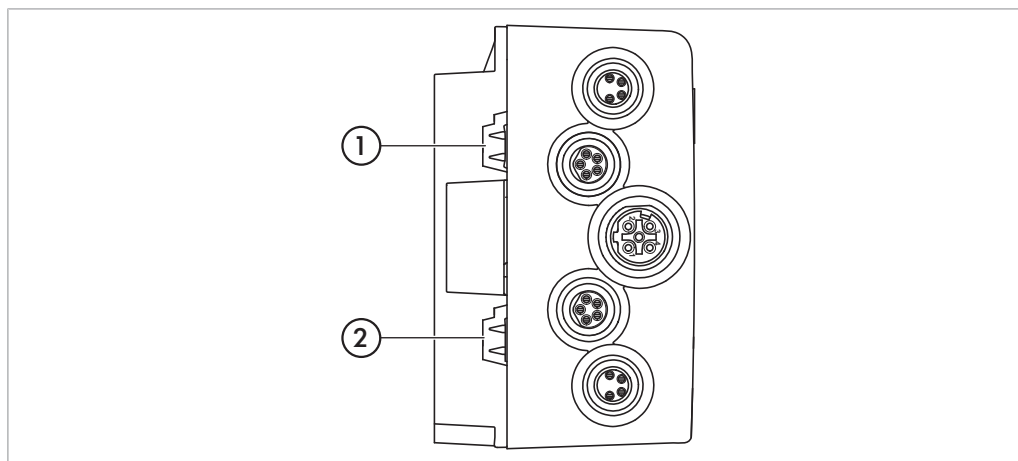

- ▶ If only one voltage supply is used, use the top cable duct with the label "Power RollerDrive" (1). In this case, close the lower cable duct (2) with a stub to achieve protection rating IP54.
- ▶ If necessary take measures for strain relief or vibration reduction.
- ▶ Close the ends of the flat cables with end caps to achieve degree of protection IP54.
- ▶ Install MultiControl on the base frame to establish the correct contact bonding (See "Initial assembly", page 15).

Assembly and installation



If the MultiControl has to be removed after bonding, the flat cable must not be reconnected at the same point as otherwise a proper contact cannot be ensured. On this case, the MultiControl has to be repositioned (See "Repeated assembly", page 16).

Connecting the RollerDrive

The four connectors 'RD1' to 'RD4' are prepared for the RollerDrive EC310. The RollerDrive EC310 connection cable is already fitted with a suitable plug.

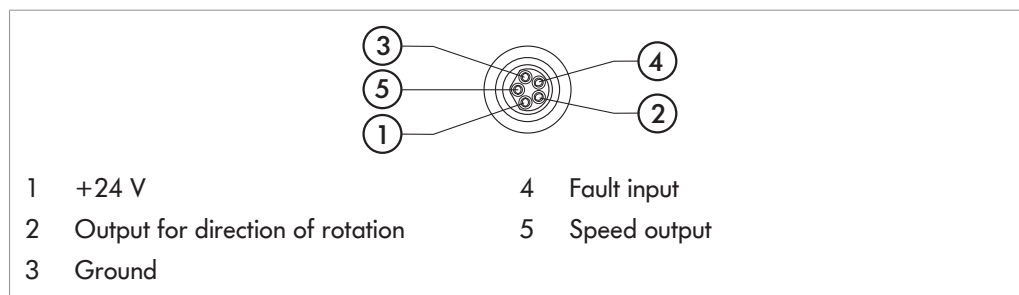

- ▶ Insert the plug so that the labeling *EC310* on the plug points to the rear, i.e. it cannot be read.
- ▶ If a RollerDrive connection remains unused, seal it with an M8 blind cap to achieve degree of protection IP54.

NOTICE

Connections are not short-circuit-proof

The MultiControl can be destroyed by a short circuit, particularly between Pin 1 and Pin 3.

- ▶ Ensure the correct polarity.

Assembly and installation

Connecting the bus

The two connections 'Link A' and 'Link B' are suitable for M12 plugs, 4-pin, D-coded, pin assignment according to IEC 61076-2-101:

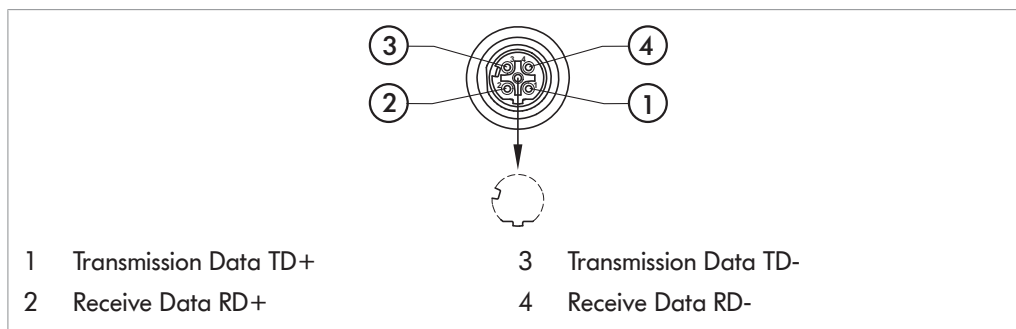

The MultiControl is equipped with an integrated 2-port switch. This allows the MultiControl, e.g. to be integrated in line structures of the bus wiring.

- ▶ Observe the installation guidelines of the respective bus systems:
 - PROFINET: PROFIBUS & PROFINET International (PI), <http://www.profibus.com>
 - EtherCAT: EtherCAT Technology Group, <http://www.ethercat.org>
 - EtherNet/IP: ODVA, <http://www.odva.org>
- ▶ If a connection remains unused, seal it with an M12 blind cap to achieve protection rating IP54.

Assembly and installation

Connecting the sensors

The connectors 'Sensor 1, I/O 1' to 'Sensor 4, I/O 4' can be used to connect four sensors and four additional inputs and outputs (Aux I/O) to the MultiControl. PNP or NPN sensors as well as sensors with opening or closing contacts can be used. The sensor type and the function of the additional I/Os can be parameterized (See "Configuring inputs and outputs", page 28). The use of a Y-line allows connecting one sensor and one input/output to one connection at the same time (See "Accessories", page 42).

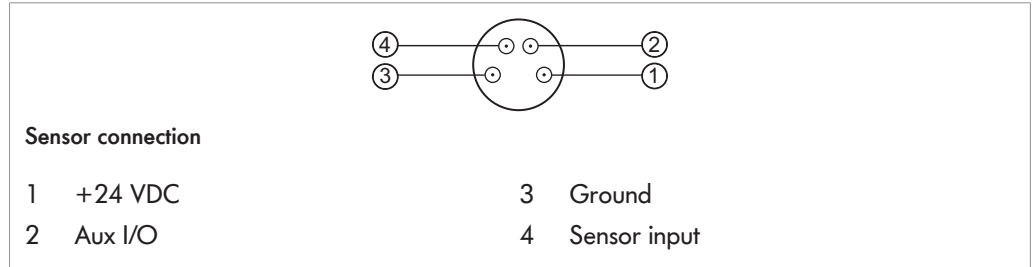

NOTICE

Connections are not short-circuit-proof

The MultiControl can be destroyed by a short circuit, particularly between Pin 1 and Pin 3.

- ▶ Ensure the correct polarity.



The inputs and outputs are not electrically isolated.

Parameters for the inputs

Input voltage	0 V to 24 V
Input resistance	≥ 15 kΩ
Switching thresholds	≥ 15 V "High" ≤ 5 V "Low"

Parameters for the outputs

Maximum output current	≤ 200 mA
Output voltage "1" with PNP	> 15 V @ 200 mA
Output voltage "1" with NPN	≤ 5 V @ 200 mA

- ▶ If a sensor connection remains unused, seal it with an M8 blind cap to achieve degree of protection IP54.

Initial startup and operation

Checks before initial startup

- ▶ Ensure that the base plate of the MultiControl is correctly fastened to the profile, that the MultiControl is correctly fastened to the base plate, and that all screws are properly tightened.
- ▶ Ensure that there are no additional areas of danger caused by interfaces to other components.
- ▶ Ensure that the wiring is in accordance with the specification and legal directives.
- ▶ Check all protection devices.
- ▶ Ensure there are no bystanders in dangerous areas around the conveyor.

Configuration options

To start up the MultiControl, it has to be configured first. There are several ways to achieve this:

- All settings can be configured using a web-based user interface on a computer connected to the MultiControl (See "*User interface*", page 23).
- All settings, except for the bus type, can be configured using Service Data Objects (SDO) that are written by a master controller (See "*Service Data Objects (SDO)*", page 24).
- With the help of the magnetic sensor, the bus type and LED indicators can be configured directly on the MultiControl and the MultiControl can be tested, automatically configured or reset to factory settings (See "*Magnetic sensor*", page 25).
- With a PLC development environment, the station name, IP configuration and connection settings can be changed.

Initial startup and operation

User interface

The MultiControl features an integrated web server generating a user interface for configuring the MultiControl. This user interface can be called up in a web browser on a computer connected to the MultiControl. Except for a web browser, no other software has to be installed on the computer.

Prerequisites

The following requirements must be met to be able to use the web-based user interface:

- The MultiControl features a valid IP address that is known (delivery state: IP address 192.168.0.1, subnet mask 255.255.255.0).
- An Ethernet connection exists between MultiControl and computer.
- Access to port 80 is possible (user interface is HTTP-based).
- MultiControl is not configured to EtherCAT since EtherCAT does not allow HTTP communication. The bus type can be read using the magnetic sensor, See "Magnetic sensor", page 25.

Starting the user interface

- ▶ Start the web browser on the computer connected with MultiControl.
- ▶ On the address line, enter the IP address of MultiControl (delivery state: http://192.168.0.1/).
- ▶ Enter the login data on the login page.
(delivery state: User name "Interroll", password "Interroll")
The start screen appears.

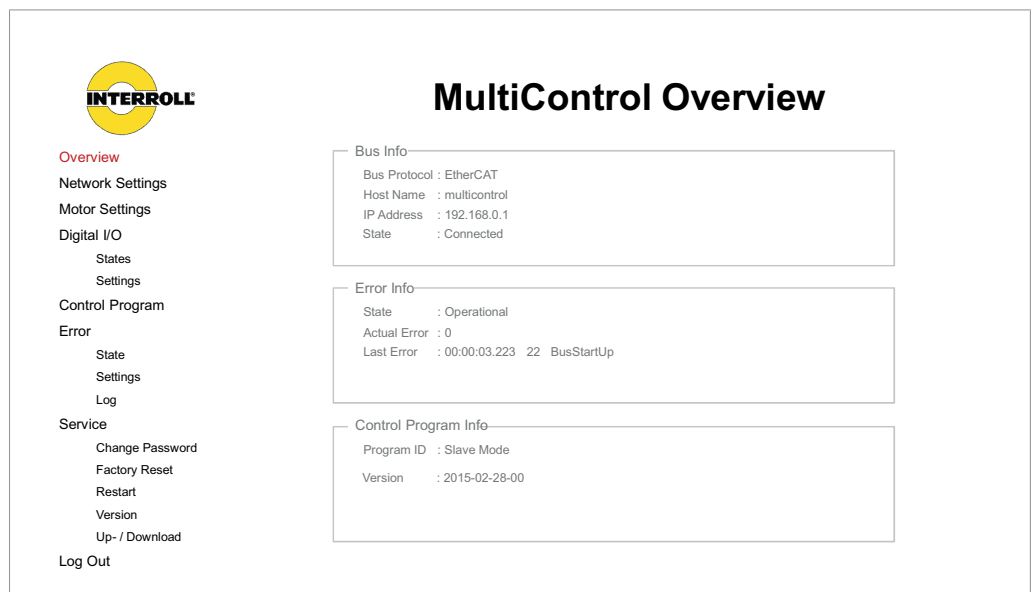

MultiControl Overview

Overview

- Network Settings
- Motor Settings
- Digital I/O
 - States
 - Settings
- Control Program
- Error
 - State
 - Settings
 - Log
- Service
 - Change Password
 - Factory Reset
 - Restart
 - Version
 - Up- / Download
- Log Out

Bus Info

- Bus Protocol : EtherCAT
- Host Name : multicontrol
- IP Address : 192.168.0.1
- State : Connected

Error Info

- State : Operational
- Actual Error : 0
- Last Error : 00:00:03.223 22 BusStartUp

Control Program Info

- Program ID : Slave Mode
- Version : 2015-02-28-00

The left side shows the navigation menu which always remains the same. The right side shows the respective information part.

- ▶ To end your work, click on "Log Out" (not necessary if MultiControl is being restarted).

Initial startup and operation

Changing the password

- ▶ In the "Service" menu, select the "Change Password" item.
- ▶ Enter the old password and then the new password twice.
- ▶ Click on "Submit" to confirm the change.



The user name cannot be changed.

Restarting MultiControl

MultiControl can be restarted via the user interface.



During the restart, the connection between MultiControl and computer/PLC is lost and has to be re-established afterwards.

- ▶ In the "Service" menu, select the "Restart" item.
- ▶ Select "Yes" in the confirmation dialog and confirm with "Submit".

Exporting/importing the settings

The settings of MultiControl can be downloaded via the user interface and saved on a computer. If the MultiControl is replaced, the settings can be restored using the data backup.

- ▶ In the "Service" menu, select the "Upload/Download" item.

Service Data Objects (SDO)

Nearly all the settings of MultiControl (except for the bus type) can be changed via acyclic communication. This communication corresponds to the Service Data Objects (SDO) of the CANopen protocol.

The SDOs are divided into indexes and subindexes. During the configuration via EtherCAT systems, index and subindex are separated by a colon (e.g. index 0x4700, subindex A becomes 0x4700:0A). For access via PROFINET and EtherNet/IP, index and subindex must be added (e.g. index 0x4700, subindex A becomes 0x470A).

Indexes of the individual functions See "*Acyclical data*", page 48.

Initial startup and operation

Magnetic sensor

The following functions can be executed with the help of the magnetic sensor:

- Perform self-test
- Set bus type
- Execute automatic configuration
- Switch LED indicators on or off
- Reset MultiControl to factory settings

A magnet is required to operate the magnetic sensor (See "Accessories", page 42). The magnetic sensor is located at the top side of MultiControl, between the two "Rs" of the "INTERROLL" label just in front of the rear plate (See "Structure", page 11).

- ▶ Hold the magnet at the magnetic sensor.
When the magnet recognizes the magnetic sensor, the "Fault" LED is permanently lit.
After 1 second, running lights start on the LED bar on the left side of MultiControl. Every LED is assigned a function (see table below).

No.	LED	Function
1	Sensor 1	Cancel
2	I/O 1	Self-test
3	RD 1	Set bus type
4	RD 2	Automatic configuration
5	Sensor 2	Switch LED indicators on or off
6	I/O 2	Reset MultiControl to factory settings

- ▶ To select a function, remove the magnet if the respective LED is lit.
2 seconds after removing the magnet, the selection of the function is accepted. During this time, the LEDs "Ready" and "Com" as well as the LED that belongs to the selection are flashing. If a second selection belongs to this function, the LED of the previous selection is flashing for approx. 7 seconds (see table below).
- ▶ To change this second selection, hold the magnet against the magnetic sensor again after 2 seconds.
Running lights are lighting up on the LED bar on the right side of MultiControl, which can be used to perform additional settings in the same way. The selection is accepted 5 seconds after removing the magnet.

Function	Selection	Selection no.	LED
3: Bus type	EtherCAT	1	Sensor 3
	PROFINET	2	I/O 3
	EtherNet/IP	3	RD 3
6: Reset MultiControl to factory settings	Confirmation		I/O 4

Initial startup and operation

LED indicators when using the magnetic sensor

When the magnet recognizes the magnetic sensor, the "Fault" LED is permanently lit. If the setting via the magnetic sensor is activated, the LEDs "Ready" and "Com" are also flashing at 1 Hz.

LED	State	Meaning
Sensor 1	On	Function 1: Cancel
I/O 1	On	Function 2: Self-test
RD 1	On	Function 3: Set bus type
RD 1 + Sensor 3	On	Selection 1 for function 3: EtherCAT
RD 1 + I/O 3	On	Selection 2 for function 3: PROFINET
RD 1 + RD 3	On	Selection 3 for function 3: EtherNet/IP
RD 2	On	Function 4: Automatic configuration
Sensor 2	On	Function 5: Switch LED indicators on or off
Sensor 2	Flashes 1 Hz	MultiControl is restarted (after selecting setting function 3 or 6)
I/O 2	On	Function 6: Reset MultiControl to factory settings
I/O 2 + I/O 4	On	Confirmation for function 6: Reset MultiControl to factory settings
Sensor 3	Flashes 1 Hz	Loading EtherCAT stack
I/O 3	Flashes 1 Hz	Loading PROFINET stack
RD 3	Flashes 1 Hz	Loading EtherNet/IP stack

Together with the following displays, the LEDs "Ready" and "Com" are flashing at 2 Hz, the "Fault" LED is off.

LED	State	Meaning
RD 1 Sensor 3	On Flashes 2 Hz	"EtherCAT" selection active, magnetic sensor not (any longer) actuated
RD 1 I/O 3	On Flashes 2 Hz	"PROFINET" selection active, magnetic sensor not (any longer) actuated
RD 1 RD 3	On Flashes 2 Hz	"EtherNet/IP" selection active, magnetic sensor not (any longer) actuated
I/O 2 I/O 4	On Flashes 2 Hz	Confirmation for function 6: Reset selected, magnetic sensor not (any longer) actuated

Configuring MultiControl

Setting bus parameters

Bus parameters may have to be changed for MultiControl to be integrated into an automation system. This includes the setting of the bus type used and an addressing.

MultiControl supports the following bus types:

- PROFINET Conformance Class A
- EtherNet/IP Object Class Adapter 0X64
- EtherCAT

In its delivery state, MultiControl is set to PROFINET.

The following parameters can be changed for addressing MultiControl:

- Configuration mode of the address:
 - Static: The IP address is assigned by the user
 - BOOTP: Bootstrap Protocol (procedure for assigning network parameters to a device during startup, e.g., the IP address)
 - DHCP: Dynamic Host Configuration Protocol (expansion of BOOTP)
- IP address and subnet mask
- Gateway
- Host name: If MultiControl is used with PROFINET, the unique PROFINET name must be entered here.
- ACD (EtherNet/IP function for recognizing address conflicts)
- Domain name and DNS server
- Neighbor addresses
- Big Endian format: Specification whether PLC data are in the big endian format or not.

Configuration options:

- User interface: "Network settings" menu
- SDO: Indexes See "Bus parameters", page 50
- Magnetic sensor (bus type only): Function 3 (LED "RD 1"), See "LED indicators when using the magnetic sensor", page 26

For the changes to take effect, the MultiControl must subsequently be restarted.

NOTICE

Destruction of MultiControl due to premature switch-off of the power supply

If the power supply is switched off while the bus type is being changed, it can destroy the MultiControl.

- ▶ Ensure that the power supply is available without interruption while the bus type is being changed and until the restart is completed.



If the EtherCAT bus type is selected, the user interface can no longer be used after the restart since this bus type is not supported.

Initial startup and operation

Selecting the application module

"I/O Device" must be selected here to operate the MultiControl as I/O device. The adjustable timers 1 to 4 are without effect here and should not be adjusted.

When using the MultiControl with other internal programs, the corresponding program must be selected here, and the timers 1 to 4 be adjusted to the conveyor system.

Configuration options:

- User interface: "Control Program" menu
- SDO: Indexes See "*Application module*", page 53

Configuring inputs and outputs

MultiControl has a total of eight inputs and outputs that are divided as follows:

- Four inputs are assigned to sensor 1 to 4.
- Four I/Os can be configured as additional inputs or outputs.

For all eight inputs and outputs, the type (PNP or NPN) and the logic (positive or negative) can be defined. For the additional inputs and outputs, the function can also be defined (See "*I/O configuration*", page 55).

Configuration options:

- User interface: "Digital I/O" menu
- SDO: Indexes See "*Inputs and outputs*", page 52

Defining the motor type

For using the motor outputs, it must be specified whether the output should be used and which motor type will be connected. In the default setting, all outputs are configured for connecting a RollerDrive EC310.

The settings roller diameter, gear ratio, direction of rotation, speed, acceleration and deceleration must be adjusted to the conveyor system.

Configuration options:

- User interface: "Motor settings" menu
- SDO: Indexes See "*Motor settings*", page 51

Switching off the LED indicators

MultiControl provides the option of partially deactivating the LED indicators. This deactivates the display of the switching states of inputs/outputs and the RollerDrive.

The status LEDs ("Power", "Ready", "Com" and "Fault") and the communication LEDs ("Link A" and "Link B") are not deactivated by the setting. A RollerDrive fault is also indicated by the flashing of the respective LED ("RD1" to "RD4").

Configuration options:

- User interface
- SDO: Indexes See "*LED indicators*", page 53
- Magnetic sensor: Function 5 (LED "Sensor 2")

Defining the error behavior

MultiControl monitors several boundary conditions (such as voltages and temperature) and can generate error messages if the limits of these boundary conditions are violated. The error behavior can be configured.

The following error classes can be set for the error behavior:

- 1 = Ignore: The error is ignored. As a result, it is not shown and not logged.
- 2 = Warning: The error is indicated via the "Error" LED and is logged.
- 3 = Normal Stop: The error leads to an immediate shut-off of the motor.

Initial startup and operation

- 4 = Immediate Stop: The error leads to an immediate shut-off of the motor.

A higher-level error class always includes the behavior of all lower-level classes (except for class 1).

The following errors can be reported:

- "Network Error": Communication to the PLC. The factory setting is "Warning". After startup, the value must be set to "Immediate Stop" in conjunction with a master control system.
- "Over Voltage Error" and "Under Voltage Error": Upper and lower limit of motor and logic voltage. The factory setting is "Warning".
- "Motor Error": Error signal of RollerDrive or RollerDrive not connected to activated motor output. The factory setting is "Normal Stop".
- "General Control Error": Error in the application module. The factory setting is "Ignore". This error is currently without function.
- "Control Error 1 – 8": Currently without function.

Configuration options:

- User interface: "Error" menu
- SDO: Indexes See *"Error behavior"*, page 54 and See *"Error information"*, page 49

Resetting to factory settings

Resetting the factory settings deletes all previous settings and set the values back to those of the delivery state.

Execution options:

- User interface: "Service" menu
- Magnetic sensor: Function 6 (LED "I/O 2")

Reading out version information

The version information can be accessed as read-only.

Access options:

- User interface: "Service" menu
- SDO: Indexes See *"Version information"*, page 48 and See *"Control program information"*, page 49

Operation



⚠ CAUTION

Accidental start-up of the RollerDrive

Danger of crushing of limbs and damage to goods

- ▶ Ensure that no persons are in the conveyor's danger areas before switching on the power supply.

If the MultiControl functions as network card, it cannot automatically start or stop motors or executed other actions. To do so, it requires commands from a master controller, e.g. a PLC (See "Process data", page 31).

Pre-startup checks

- ▶ Check all MultiControl for visible damage.
- ▶ Check all protection devices.
- ▶ Ensure that no RollerDrive connected to the MultiControl is blocked.
- ▶ Clearly specify and monitor the way goods are placed on the conveyor.
- ▶ Ensure there are no bystanders in dangerous areas around the conveyor.

Start

- ▶ Ensure that the operating conditions are complied with during operation (See "Technical data", page 13).
- ▶ Switch on the power supply.
- ▶ Send the corresponding signal to the MultiControl (See "Process data", page 31).

Stop

Conveying stops in the following cases:

- If the power supply is switched off.
- If no signal for the start is present.
- If an error from a corresponding error class is present (See "Defining the error behavior", page 28).

Initial startup and operation

Process data

The process data are divided into two parts: the process image of the inputs and the process image of the outputs.

The addresses specified in this chapter are intended as offset to the start addresses specified in the configuration of the PLC.

Explanation about the data types See "Data types", page 42.

Process image of the inputs

The process image of the inputs is divided into four parts: Sensors, Digital I/O, Motor Status and Others.

Sensors

The information of the switching states of the sensors is located in the first BYTE of the process image. The first four bits contain the physical state of the inputs Sensor 1 to 4, depending on the set PNP/NPN configuration and positive or negative polarity.

The inputs Sensor 5 to 8 are displayed only if the I/Os 1 to 4 are configured as additional sensors.

Designation	BYTE	Bit	Data type	Comment
Sensor 1	0	0	BOOL	Input "Sensor 1"
Sensor 2	0	1	BOOL	Input "Sensor 2"
Sensor 3	0	2	BOOL	Input "Sensor 3"
Sensor 4	0	3	BOOL	Input "Sensor 4"
Sensor 5	0	4	BOOL	Input "Sensor 5"
Sensor 6	0	5	BOOL	Input "Sensor 6"
Sensor 7	0	6	BOOL	Input "Sensor 7"
Sensor 8	0	7	BOOL	Input "Sensor 8"

Digital I/O

The second BYTE contains the states of the digital I/Os. The value of the variables depends on the PNP/NPN configuration and positive or negative polarity. If the I/O is used as output, the specified switching state is also displayed here.

Designation	BYTE	Bit	Data type	Comment
I/O 1	1	0	BOOL	Input "I/O 1"
I/O 2	1	1	BOOL	Input "I/O 2"
I/O 3	1	2	BOOL	Input "I/O 3"
I/O 4	1	3	BOOL	Input "I/O 4"
Reserve	1	4	BOOL	These four bits are currently not in use.
	1	5	BOOL	
	1	6	BOOL	
	1	7	BOOL	

Initial startup and operation

Motor status

Starting with the third BYTE, it contains the status values of the connected motors.

First, the error outputs of the connected motors are returned. In this case, a logical ONE at the input means "Motor is Error state". To prevent unused motor connections from causing any errors, the connections should also be deactivated if MultiControl is used as network card (See "Defining the motor type", page 28).

Second, the set values of the motors are output.

Third, the current consumptions of the motors are indicated.

Designation	BYTE	Bit	Data type	Comment
Motor error 1	2	0	BOOL	Input motor error "RD 1"
Motor error 2	2	1	BOOL	Input motor error "RD 2"
Motor error 3	2	2	BOOL	Input motor error "RD 3"
Motor error 4	2	3	BOOL	Input motor error "RD 4"
Reserve	2	4	BOOL	These four bits are currently not in use.
	2	5	BOOL	
	2	6	BOOL	
	2	7	BOOL	
Speed 1	3		SINT	[%], speed setpoint motor 1
Speed 2	4		SINT	[%], speed setpoint motor 2
Speed 3	5		SINT	[%], speed setpoint motor 3
Speed 4	6		SINT	[%], speed setpoint motor 4
Reserve	7		BYTE	This BYTE is currently not in use.
Motor current 1	8		INT	[mA] motor current motor 1
Motor current 2	10		INT	[mA] motor current motor 2
Motor current 3	12		INT	[mA] motor current motor 3
Motor current 4	14		INT	[mA] motor current motor 4

Initial startup and operation

System status

The fourth area of the process image of the inputs contains the following status information of the system: the current level of both supply voltages, the temperature and the runtime since the last restart.

Designation	BYTE	Data type	Comment
Voltage 1	16	INT	[mV] supply voltage "Power Motor"
Voltage 2	18	INT	[mV] supply voltage "Power Logic+Sensors", a value is also output here if the second voltage supply is not connected.
Temperature	20	INT	[d°C] temperature of MultiControl
SystemUpTime	22	LINT	[s] time since last restart

Additional signals

The last part of the process image of the inputs is subdivided into five subsections:

- Control inputs
- Control outputs
- Handshake signals
- Zone status
- Global signals

These input signals are not relevant to the use of MultiControl as network card.

Process image of the outputs

The process image of the outputs is divided into three parts: Digital I/O, Motors and Other signals.

Digital outputs

The digital outputs are located in the first part process image of the outputs. The outputs can be directly switched by a PLC only if the I/O is set to "2: PLC-Output". The physical state at the output also depends on the configuration of the output (PNP/NPN, positive or negative polarity).

Designation	BYTE	Bit	Data type	Comment
I/O 1	0	0	BOOL	Output "I/O 1"
I/O 2	0	1	BOOL	Output "I/O 2"
I/O 3	0	2	BOOL	Output "I/O 3"
I/O 4	0	3	BOOL	Output "I/O 4"
Reserve	0	4	BOOL	These four bits are currently not in use.
	0	5	BOOL	
	0	6	BOOL	
	0	7	BOOL	

Motors

The second part of the process image of the outputs contains the outputs for the reference setting of the connected motors.

Initial startup and operation

Designation	BYTE	Bit	Data type	Comment
Speed 1	1		SINT	[%], speed setpoint motor 1
Speed 2	2		SINT	[%], speed setpoint motor 2
Speed 3	3		SINT	[%], speed setpoint motor 3
Speed 4	4		SINT	[%], speed setpoint motor 4

The speed of the connected RollerDrives depends on the gear ratio.

- ▶ To set the speed, switch a percentage value between 5 and 100 according to the table below to the "Speed" output at the "RD" connection of MultiControl. (Values not listed can be interpolated in a linear way.)
- ▶ To reverse the direction of rotation, use negative values between -5 and -100.

Speed output at the "RD" connection	Speed at gear ratio [m/s]								
	9:1	12:1	16:1	20:1	24:1	36:1	48:1	64:1	96:1
0	0.00	0.00	0.00	0.00	0.00	0.00	0.00	0.00	0.00
5	0.09	0.07	0.05	0.04	0.03	0.02	0.02	0.01	0.01
10	0.17	0.13	0.10	0.08	0.07	0.04	0.03	0.02	0.02
15	0.26	0.20	0.15	0.12	0.10	0.07	0.05	0.04	0.02
20	0.35	0.26	0.20	0.16	0.13	0.09	0.07	0.05	0.03
25	0.44	0.33	0.25	0.20	0.16	0.11	0.08	0.06	0.04
30	0.52	0.39	0.29	0.24	0.20	0.13	0.10	0.07	0.05
35	0.61	0.46	0.34	0.27	0.23	0.15	0.11	0.09	0.06
40	0.70	0.52	0.39	0.31	0.26	0.17	0.13	0.10	0.07
45	0.79	0.59	0.44	0.35	0.29	0.20	0.15	0.11	0.07
50	0.87	0.65	0.49	0.39	0.33	0.22	0.16	0.12	0.08
55	0.96	0.72	0.54	0.43	0.36	0.24	0.18	0.13	0.09
60	1.05	0.79	0.59	0.47	0.39	0.26	0.20	0.15	0.10
65	1.13	0.85	0.64	0.51	0.43	0.28	0.21	0.16	0.11
70	1.22	0.92	0.69	0.55	0.46	0.31	0.23	0.17	0.11
75	1.31	0.98	0.74	0.59	0.49	0.33	0.25	0.18	0.12
80	1.40	1.05	0.79	0.63	0.52	0.35	0.26	0.20	0.13
85	1.48	1.11	0.83	0.67	0.56	0.37	0.28	0.21	0.14
90	1.57	1.18	0.88	0.71	0.59	0.39	0.29	0.22	0.15
95	1.66	1.24	0.93	0.75	0.62	0.41	0.31	0.23	0.16
100	1.75	1.31	0.98	0.79	0.65	0.44	0.33	0.25	0.16

Initial startup and operation

Additional signals

The last part of the process image of the outputs is subdivided into three subsections:

- Control inputs overwrite
- Control outputs overwrite
- Handshake signals overwrite

Maintenance and cleaning

Warning notices concerning maintenance and cleaning

CAUTION

Risk of injuries due to incorrect handling

- ▶ Maintenance work and cleaning must only be performed by qualified and authorized persons.
 - ▶ Perform maintenance work only after switching off the power. Ensure that the MultiControl cannot be turned on accidentally.
 - ▶ Set up signs indicating that maintenance work is in progress.
-

Maintenance

Checking MultiControl

The MultiControl itself is maintenance-free. For avoidance of faults however, regular inspection of the connections and fixings is recommended.

- ▶ As part of the regular control and maintenance work on the conveyor, ensure that the screws of the MultiControl are still tight and that the cables are still laid properly and connected to the terminals.

Replacing MultiControl

If a MultiControl is damaged, it has to be replaced.

- ▶ Install a new MultiControl (See "Shutdown", page 37 and See "Assembly and installation", page 15).
- ▶ Configure a new MultiControl (See "Initial startup and operation", page 22).

Cleaning

Dust and dirt in combination with humidity may bridge the electric circuit. Therefore, in a dirty environment, periodic cleaning will help to avoid short-circuits which could damage the MultiControl.

NOTICE

Risk of damage to the MultiControl due to incorrect cleaning

- ▶ Do not immerse the MultiControl in liquids.
-
- ▶ Clean away dust and soiling if necessary.
 - ▶ For more thorough cleaning, disconnect the MultiControl from the power supply, remove it, and wipe over it with a damp cloth.

Decommissioning and disposal

Shutdown

CAUTION

Risk of injuries due to incorrect handling

- ▶ Shut-down may only be executed by qualified and authorized persons.
 - ▶ Only abandon the MultiControl after switching off the power. Ensure that the MultiControl cannot be turned on accidentally.
-
- ▶ Disconnect all cables from the MultiControl.
 - ▶ Loosen the screws with which the MultiControl is fastened to the base plate and pull off MultiControl.
 - ▶ If the MultiControl is to be completely disassembled, also loosen the screws with which the base plate is fastened to the conveyor frame and remove the base plate from the conveyor frame.

Disposal

The operator is responsible for the proper disposal of the MultiControl.

- ▶ In doing so, industry-specific and local provisions must be observed for the disposal of the MultiControl and its packaging.
- ▶ The packaging must be recycled to provide environmental relief.

Troubleshooting

Meaning of the LEDs

LEDs on the MultiControl inform about the operating state of the conveyor.

Status descriptions of the LEDs:

- Off: LED is permanently off
- On: LED is permanently on
- Flashes 1 Hz: LED flashes at a frequency of 1 Hz; pulse duty factor 1:1
- Flashes 2 Hz: LED flashes at a frequency of 2 Hz; pulse duty factor 1:1
- –: LED state is variable

General LEDs

Power	Ready	Com	Fault	Meaning	Priority
On	On	On	Off	Operational, no error	
–	On	Flashes 1 Hz	Off	Bus startup mode: After starting, the system waits up to 30 s to establish the connection to the PLC.	
–	–	–	Flashes 1 x	Error in application program, e.g. timeout	1
–	–	–	Flashes 2 x	Communication fault: Connection is not established within 30 s after starting or connection to PLC is lost. Error acknowledges itself automatically.	3
–	–	–	Flashes 3 x	RollerDrive error: Defective RollerDrive is indicated by flashing of the respective "RD" LED.	2
Off	On	–	Flashes 4 x	Voltage supply for motors is missing.	5
–	–	–	Flashes 5 x	Voltage error in under voltage: Operating voltage less than 18 V (displayed starting at approx. 9 V).	4
–	–	–	Flashes 6 x	Voltage error in over voltage: Logic voltage greater than 28 V, voltage protection up to 30 V.	4
–	–	–	Flashes 7 x	Temperature in MultiControl too high.	6
–	–	–	Flashes 8 x	Overload protection of brake chopper resistor active.	7
–	–	–	Flashes 9 x	Handshake communication malfunctioning. See instructions for ZPA and ZPA+ applications.	
–	–	–	Flashes 10 x	No connection to the neighbor. See instructions for ZPA and ZPA+ applications.	



If several errors occur at the same time, only the error with the highest priority is displayed.

Troubleshooting

Removal of errors See "Error messages", page 40.

LEDs of connections

LED	State	Meaning
Sensor 1	On	Logic switching state of displayed sensor:
Sensor 2		Positive logic configured and logical "1" (PNP 24 V, NPN 0 V) at
Sensor 3		input
Sensor 4		- or - Negative logic configured and logical "0" at input
I/O 1	On	Logic switching state of displayed input/output:
I/O 2		Positive logic configured and logical "1" (PNP 24 V, NPN 0 V) at
I/O 3		input
I/O 4		- or - Negative logic configured and logical "0" at input
RD 1	On	Displayed RollerDrive receives nominal value
RD 2		
RD 3		
RD 4		
Link A	Flashing	Displayed network connection is OK
Link B		

Troubleshooting

Troubleshooting

The MultiControl is a complex system. There are many interactions between all system components. Naturally, errors can occur in such a system which either result from the conveying processes or the interaction between the individual components. Not all errors can be shown in detail and the error location and display location cannot always be allocated to each other. A better error diagnostics is possible via the PLC.

If troubleshooting is not successful, please contact Interroll support and have the following information at hand:

- Serial number of the affected MultiControl.
- Details of the configuration
- Details of the LED displays
- Details of the error codes

Error messages

Error message	Possible cause	Remedy
Communication fault	Connection to the PLC is malfunctioning	<ul style="list-style-type: none"> ▶ Check bus wiring. ▶ Check bus type. ▶ Check network address and bus name.
RollerDrive error	Error signal of RollerDrive or RollerDrive not connected to activated motor output	<ul style="list-style-type: none"> ▶ Check motor configuration. ▶ Ensure that all RollerDrives are correctly connected. ▶ Check for malfunctions according to the RollerDrive operating instructions.
Voltage supply for motors is missing		<ul style="list-style-type: none"> ▶ Check supply voltage. (Is Emergency Stop possibly activated?)
Undervoltage	Voltage supply is below 19 V	<ul style="list-style-type: none"> ▶ Ensure that the supply voltage is above 19 V.
Overvoltage	Voltage supply is above 30 V	<ul style="list-style-type: none"> ▶ Ensure that the supply voltage is below 26 V.

Troubleshooting

Additional faults

Fault	Possible cause	Remedy
The MultiControl is not working or is working incorrectly	No or insufficient power supply	<ul style="list-style-type: none"> ▶ Check whether the output voltage of the power supply is within the specified voltage range. ▶ Check the connections and correct if necessary.
The MultiControl is defective or damaged	Internal fuse triggered or faulty.	▶ Replace the MultiControl.
RollerDrive does not rotate	RollerDrive not or not correctly inserted or RollerDrive defective	<ul style="list-style-type: none"> ▶ Check whether the power supply is within the specified voltage range. ▶ Check the connections and correct if necessary. ▶ Replace the RollerDrive if necessary.
	Brake chopper overheats: The application feeds back too much energy or the voltage supply is too high	<ul style="list-style-type: none"> ▶ Allow to cool down. ▶ Lower ambient temperature if necessary. ▶ Check voltage supply and set to 24 V if necessary.

Appendix

Accessories

Designation	Reference number
Cable bridge	S-1004028
Flat cable for voltage (3G3G-FL, 2 x 2.5 mm ² , black, 25-m sections)	S-1004030
400-V power supply	S-1004029
Address magnet	S-64100210
Y-line 3-pin	S-1104439
Y-line 4-pin	S-1104460
EtherNet line M12/M12 (3 m)	S-1104438
MultiControl enclosure: 1 x M12 dummy plug 3 x M8 Snap-in dummy plug 3 x M8 screw connection dummy plug	S-1104466
Extension cable for RollerDrive EC310, (2 m)	S-1004033

Data types

The following data types are used for cyclical and acyclical communication with MultiControl:

- **BOOL:** Boolean = truth value (true/false)
- **BYTE:** Bit sequence with 8 bits
- **SINT:** Short Integer = integer variable with 8 bits
- **USINT:** Unsigned Short Integer = positive integer variable with 8 bits
- **INT:** Integer = integer variable with 16 bits
- **UINT:** Unsigned Integer = positive integer variable with 16 bits
- **DINT:** Double Integer = integer variable with 32 bits
- **UDINT:** Unsigned Double Integer = positive integer variable with 32 bits
- **LINT:** Long Integer = integer variable with 64 bits
- **STRING:** Character string with up to 31 characters

Appendix

Cyclical process image

Input

No.	Category	Byte	Bit	Designation	Type	Comment
1	Sensors	0	.0	Sensor 1	BOOL	Status at "Sensor 1" input High/Low = Sensor blocked / not blocked; logical status, voltage level depends on configuration (NPN/PNP; polarity)
2	Sensors	0	.1	Sensor 2	BOOL	Status at input "Sensor 2", see above
3	Sensors	0	.2	Sensor 3	BOOL	Status at input "Sensor 3", see above
4	Sensors	0	.3	Sensor 4	BOOL	Status at input "Sensor 4", see above
5	Sensors	0	.4	Sensor 5	BOOL	Input dependent on configuration, e.g. "Aux 1" configured as sensor 5
6	Sensors	0	.5	Sensor 6	BOOL	
7	Sensors	0	.6	Sensor 7	BOOL	
8	Sensors	0	.7	Sensor 8	BOOL	
9	Digital I/Os	1	.0	IO 1	BOOL	Logical state, voltage level depends on configuration (NPN/PNP; polarity)
10	Digital I/Os	1	.1	IO 2	BOOL	
11	Digital I/Os	1	.2	IO 3	BOOL	
12	Digital I/Os	1	.3	IO 4	BOOL	
13	Digital I/Os	1	.4	Reserve	BOOL	Not used
14	Digital I/Os	1	.5	Reserve	BOOL	Not used
15	Digital I/Os	1	.6	Reserve	BOOL	Not used
16	Digital I/Os	1	.7	Reserve	BOOL	Not used
17	MotorStates	2	.0	Error Motor 1	BOOL	High = motor error, Low = motor OK
18	MotorStates	2	.1	Error Motor 2	BOOL	
19	MotorStates	2	.2	Error Motor 3	BOOL	
20	MotorStates	2	.3	Error Motor 4	BOOL	
21	MotorStates	2	.4	Reserve	BOOL	Not used
22	MotorStates	2	.5	Reserve	BOOL	Not used
23	MotorStates	2	.6	Reserve	BOOL	Not used
24	MotorStates	2	.7	Reserve	BOOL	Not used
25	MotorStates	3		Speed Motor 1	SINT	Speed 0...100 (0 = stop, 100 = max. speed), negative values indicate reversed direction of rotation
26	MotorStates	4		Speed Motor 2	SINT	
27	MotorStates	5		Speed Motor 3	SINT	
28	MotorStates	6		Speed Motor 4	SINT	

Appendix

No.	Category	Byte	Bit	Designation	Type	Comment
29	MotorStates	7		Reserve	BYTE	Reserve byte so that data words are positioned correctly
30	MotorStates	8		Current1	INT	Average motor current in mA
31	MotorStates	10		Current2	INT	
32	MotorStates	12		Current3	INT	
33	MotorStates	14		Current4	INT	
34	SystemState	16		Voltage_Motor	INT	"Motor Power" voltage in mV
35	SystemState	18		Voltage_Logic	INT	"Power Logic+Sensors" voltage in mV
36	SystemState	20		Temperature	INT	Temperature in 0.1 °C
37	SystemState	22		SystemUpTime	DINT	Operating time in seconds since last start/restart
38	Control inputs	26	.0	ControllInput 1	BOOL	See instructions for ZPA and ZPA+ applications
39	Control inputs	26	.1	ControllInput 2	BOOL	See instructions for ZPA and ZPA+ applications
40	Control inputs	26	.2	ControllInput 3	BOOL	See instructions for ZPA and ZPA+ applications
41	Control inputs	26	.3	ControllInput 4	BOOL	See instructions for ZPA and ZPA+ applications
42	Control inputs	26	.4	ControllInput 5	BOOL	See instructions for ZPA and ZPA+ applications
43	Control inputs	26	.5	ControllInput 6	BOOL	See instructions for ZPA and ZPA+ applications.
44	Control inputs	26	.6	ControllInput 7	BOOL	See instructions for ZPA and ZPA+ applications.
45	Control inputs	26	.7	ControllInput 8	BOOL	See instructions for ZPA and ZPA+ applications.
46	Control inputs	27		DecisionByte	BYTE	See instructions for ZPA and ZPA+ applications.
47	Control outputs	28	.0	ControlOutput1	BOOL	See instructions for ZPA and ZPA+ applications.
48	Control outputs	28	.1	ControlOutput2	BOOL	See instructions for ZPA and ZPA+ applications.
49	Control outputs	28	.2	ControlOutput3	BOOL	See instructions for ZPA and ZPA+ applications.
50	Control outputs	28	.3	ControlOutput4	BOOL	See instructions for ZPA and ZPA+ applications.
51	Control outputs	28	.4	ControlOutput5	BOOL	See instructions for ZPA and ZPA+ applications.
52	Control outputs	28	.5	ControlOutput6	BOOL	See instructions for ZPA and ZPA+ applications.
53	Control outputs	28	.6	ControlOutput7	BOOL	See instructions for ZPA and ZPA+ applications.
54	Control outputs	28	.7	ControlOutput8	BOOL	See instructions for ZPA and ZPA+ applications.
55	Handshake Signals	29	.0	In Up	BOOL	See instructions for ZPA and ZPA+ applications.
56	Handshake Signals	29	.1	In Down	BOOL	See instructions for ZPA and ZPA+ applications.
57	Handshake Signals	29	.2	In Left	BOOL	See instructions for ZPA and ZPA+ applications.
58	Handshake Signals	29	.3	In Right	BOOL	See instructions for ZPA and ZPA+ applications.
59	Handshake Signals	29	.4	Out Up	BOOL	See instructions for ZPA and ZPA+ applications.
60	Handshake Signals	29	.5	Out Down	BOOL	See instructions for ZPA and ZPA+ applications.
61	Handshake Signals	29	.6	Out Left	BOOL	See instructions for ZPA and ZPA+ applications.
62	Handshake Signals	29	.7	Out Right	BOOL	See instructions for ZPA and ZPA+ applications.
63	ZoneStates	30	.0	ZoneBusy1	BOOL	See instructions for ZPA and ZPA+ applications.

Appendix

No.	Category	Byte	Bit	Designation	Type	Comment
64	ZoneStates	30	.1	ZoneBusy2	BOOL	See instructions for ZPA and ZPA+ applications.
65	ZoneStates	30	.2	ZoneBusy3	BOOL	See instructions for ZPA and ZPA+ applications.
66	ZoneStates	30	.3	ZoneBusy4	BOOL	See instructions for ZPA and ZPA+ applications.
67	ZoneStates	30	.4	Reserve	BOOL	See instructions for ZPA and ZPA+ applications.
68	ZoneStates	30	.5	Reserve	BOOL	See instructions for ZPA and ZPA+ applications.
69	ZoneStates	30	.6	Reserve	BOOL	See instructions for ZPA and ZPA+ applications.
70	ZoneStates	30	.7	Reserve	BOOL	See instructions for ZPA and ZPA+ applications.
71	ZoneStates	31		ZoneError1	BYTE	See instructions for ZPA and ZPA+ applications.
72	ZoneStates	32		ZoneError2	BYTE	See instructions for ZPA and ZPA+ applications.
73	ZoneStates	33		ZoneError3	BYTE	See instructions for ZPA and ZPA+ applications.
74	ZoneStates	34		ZoneError4	BYTE	See instructions for ZPA and ZPA+ applications.
75	Global Signals	35	.0	Reserve	BOOL	See instructions for ZPA and ZPA+ applications.
76	Global Signals	35	.1	Reserve	BOOL	See instructions for ZPA and ZPA+ applications.
77	Global Signals	35	.2	Reserve	BOOL	See instructions for ZPA and ZPA+ applications.
78	Global Signals	35	.3	Reserve	BOOL	See instructions for ZPA and ZPA+ applications.
79	Global Signals	35	.4	Reserve	BOOL	See instructions for ZPA and ZPA+ applications.
80	Global Signals	35	.5	Reserve	BOOL	See instructions for ZPA and ZPA+ applications.
81	Global Signals	35	.6	Reserve	BOOL	See instructions for ZPA and ZPA+ applications.
82	Global Signals	35	.7	Reserve	BOOL	

Appendix

Output

No.	Category	Byte	Bit	Designation	Type	Comment
1	Digital outputs	0	.0	PLC Output1	BOOL	Logical state, voltage level depends on I/O configuration (NPN/PNP type; polarity)
2	Digital outputs	0	.1	PLC Output2	BOOL	
3	Digital outputs	0	.2	PLC Output3	BOOL	
4	Digital outputs	0	.3	PLC Output4	BOOL	
5	Digital outputs	0	.4	Reserve	BOOL	
6	Digital outputs	0	.5	Reserve	BOOL	
7	Digital outputs	0	.6	Reserve	BOOL	
8	Digital outputs	0	.7	Reserve	BOOL	
9	Motor	1		Speed1	SINT	Speed 0...100 (0 = stop, 100 = max. speed), negative values indicate reversed direction of rotation
10	Motor	2		Speed2	SINT	
11	Motor	3		Speed3	SINT	
12	Motor	4		Speed4	SINT	
13	Control inputs overwrite	5	.0	ControllInput1	BOOL	See instructions for ZPA and ZPA+ applications.
14	Control inputs overwrite	5	.1	ControllInput2	BOOL	See instructions for ZPA and ZPA+ applications.
15	Control inputs overwrite	5	.2	ControllInput3	BOOL	See instructions for ZPA and ZPA+ applications.
16	Control inputs overwrite	5	.3	ControllInput4	BOOL	See instructions for ZPA and ZPA+ applications.
17	Control inputs overwrite	5	.4	ControllInput5	BOOL	See instructions for ZPA and ZPA+ applications.
18	Control inputs overwrite	5	.5	ControllInput6	BOOL	See instructions for ZPA and ZPA+ applications.
19	Control inputs overwrite	5	.6	ControllInput7	BOOL	See instructions for ZPA and ZPA+ applications.
20	Control inputs overwrite	5	.7	ControllInput8	BOOL	See instructions for ZPA and ZPA+ applications.
21	Control inputs overwrite	6		DecisionInput	BYTE	See instructions for ZPA and ZPA+ applications.
22	Control outputs overwrite	7	.0	ControlOutput1	BOOL	See instructions for ZPA and ZPA+ applications.
23	Control outputs overwrite	7	.1	ControlOutput2	BOOL	See instructions for ZPA and ZPA+ applications.
24	Control outputs overwrite	7	.2	ControlOutput3	BOOL	See instructions for ZPA and ZPA+ applications.
25	Control outputs overwrite	7	.3	ControlOutput4	BOOL	See instructions for ZPA and ZPA+ applications.
26	Control outputs overwrite	7	.4	ControlOutput5	BOOL	See instructions for ZPA and ZPA+ applications.
27	Control outputs overwrite	7	.5	ControlOutput6	BOOL	See instructions for ZPA and ZPA+ applications.
28	Control outputs overwrite	7	.6	ControlOutput7	BOOL	See instructions for ZPA and ZPA+ applications.
29	Control outputs overwrite	7	.7	ControlOutput8	BOOL	See instructions for ZPA and ZPA+ applications.
30	Handshake Signals Overwrite	8	.0	In Up	BOOL	See instructions for ZPA and ZPA+ applications.
31	Handshake Signals Overwrite	8	.1	In Down	BOOL	See instructions for ZPA and ZPA+ applications.
32	Handshake Signals Overwrite	8	.2	In Left	BOOL	See instructions for ZPA and ZPA+ applications.
33	Handshake Signals Overwrite	8	.3	In Right	BOOL	See instructions for ZPA and ZPA+ applications.
34	Handshake Signals Overwrite	8	.4	Out Up	BOOL	See instructions for ZPA and ZPA+ applications.

Appendix

No.	Category	Byte	Bit	Designation	Type	Comment
35	Handshake Signals Overwrite	8	.5	Out Down	BOOL	See instructions for ZPA and ZPA+ applications.
36	Handshake Signals Overwrite	8	.6	Out Left	BOOL	See instructions for ZPA and ZPA+ applications.
37	Handshake Signals Overwrite	8	.7	Out Right	BOOL	See instructions for ZPA and ZPA+ applications.
38	Global Signals	9	.0	Reserve	BOOL	See instructions for ZPA and ZPA+ applications.
39	Global Signals	9	.1	Reserve	BOOL	See instructions for ZPA and ZPA+ applications.
40	Global Signals	9	.2	Reserve	BOOL	See instructions for ZPA and ZPA+ applications.
41	Global Signals	9	.3	Reserve	BOOL	See instructions for ZPA and ZPA+ applications.
42	Global Signals	9	.4	Reserve	BOOL	See instructions for ZPA and ZPA+ applications.
43	Global Signals	9	.5	Reserve	BOOL	See instructions for ZPA and ZPA+ applications.
44	Global Signals	9	.6	Reserve	BOOL	See instructions for ZPA and ZPA+ applications.
45	Global Signals	9	.7	Reserve	BOOL	

Appendix

Acyclical data

The SDOs are divided into indexes and subindexes. During the configuration via EtherCAT systems, index and subindex are separated by a colon (e.g. index 0x4700, subindex A becomes 0x4700:0A). For access via PROFINET and EtherNet/IP, index and subindex must be added (e.g. index 0x4700, subindex A becomes 0x470A).

Version information SDO index: 0x4000

Subindex	Designation	Data type	Access	Comment
1	Hardware	STRING	R	
2	Application Software	STRING	R	
3	System Software	STRING	R	
4	Network Software	STRING	R	

Manufacturer information SDO index: 0x4100

Subindex	Designation	Data type	Access	Comment
1	Serial Number	STRING	R	
2	Manufacture Date	STRING	R	

Diagnostic information SDO index: 0x4200

Subindex	Designation	Data type	Access	Comment
1	Motor voltage act. [mV]	INT	R	Effective motor supply voltage
2	Motor voltage max. [mV]	INT	R	Maximum motor supply voltage
3	Motor voltage min. [mV]	INT	R	Minimum motor supply voltage
4	Logic voltage act. [mV]	INT	R	Effective logic supply voltage
5	Logic voltage max. [mV]	INT	R	Maximum logic supply voltage
6	Logic voltage min. [mV]	INT	R	Minimum logic supply voltage
7	Temperature act. [d°C]	INT	R	Effective temperature
8	Temperature max. [d°C]	INT	R	Maximum temperature
9	Temperature min. [d°C]	INT	R	Minimum temperature

Appendix

Error information SDO index: 0x4300

Subindex	Designation	Data type	Access	Comment
1	Error State	BYTE	R	1 = operating 2 = minor error 3 = severe error
2	Error Code	UINT	R	Error number of last error (0 = no error)
3	Time Motor Error 1	UDINT	R	Time since last error from motor 1
4	Time Motor Error 2	UDINT	R	Time since last error from motor 2
5	Time Motor Error 3	UDINT	R	Time since last error from motor 3
6	Time Motor Error 4	UDINT	R	Time since last error from motor 4

Network online time SDO index: 0x4400

Subindex	Designation	Data type	Access	Comment
0	Network Online Time	UDINT	R	Operating time of bus

Control program information SDO index: 0x4500

Subindex	Designation	Data type	Access	Comment
1	Selected State Table	UINT	R	Selected application program
2	Version Year	UINT	R	Version of application program
3	Version Month	USINT	R	
4	Version Day	USINT	R	
5	Version Hour	USINT	R	
6	IO 1 Usage	BYTE	R	IO 1 is used in the selected application program
7	IO 2 Usage	BYTE	R	IO 2 is used in the selected application program
8	IO 3 Usage	BYTE	R	IO 3 is used in the selected application program
9	IO 4 Usage	BYTE	R	IO 4 is used in the selected application program

Appendix

Bus parameters SDO index: 0x4600

Subindex	Designation	Data type	Access	Comment
1	Bus Type	USINT	R	Bus type used: 1 = EtherCAT 2 = PROFINET 3 = EtherNet/IP
2	IP Configuration Mode	USINT	R/W	Configuration mode of the address: 1 = Static 2 = BOOTP 3 = DHCP
3	IP Address	UDINT	R/W	Own IP address
4	IP Network Mask	UDINT	R/W	Subnet mask
5	IP Gateway Address	UDINT	R/W	IP Address Default Gateway
6	IP Address DNS 1	UDINT	R/W	IP Address Domain Name Server #1
7	IP Address DNS 2	UDINT	R/W	IP Address Domain Name Server #2
8	IP Host Name	STRING	R/W	IP Host Name
9	IP Domain Name	STRING	R/W	IP Domain Name
A	ACD Enable	BOOL	R/W	Recognition of address conflicts (EtherNet/IP)
B	Quick Startup Enable	BOOL	R/W	Quickstart (PROFINET)
C	IP Address Neighbor 1	UDINT	R/W	IP address of neighbors when using ZPA and ZPA+.
D	IP Address Neighbor 2	UDINT	R/W	
S	IP Address Neighbor 3	UDINT	R/W	
F	IP Address Neighbor 4	UDINT	R/W	
10	IP Address Neighbor 5	UDINT	R/W	
11	IP Address Neighbor 6	UDINT	R/W	
12	IP Address Neighbor 7	UDINT	R/W	
13	IP Address Neighbor 8	UDINT	R/W	
14	Big Endian format:	BOOL	R/W	PLC data are in big endian format (MSB first)

Appendix

Motor settings SDO index: 0x4700

The settings of subindexes 5 to 32 are currently without effect. The speed and direction of rotation can be set via cyclical process data (See "Process image of the outputs", page 33).

Subindex	Designation	Data type	Access	Comment	Min.	Max.
1	Motor Type 1	USINT	R/W	Motor type to connection RD1: 0 = None 1 = EC310 2 = VDC_SPEED 3 = VDC_POSITION Setting 2 and are currently not being supported.	0	3
2	Motor Type 2	USINT	R/W	Motor type to connection RD2 Values see above	0	3
3	Motor Type 3	USINT	R/W	Motor type to connection RD3 Values see above	0	3
4	Motor Type 4	USINT	R/W	Motor type to connection RD4 Values see above	0	3
5	Direction CW 1	BOOL	R/W	TRUE = RollerDrive 1 turns clockwise FALSE = RollerDrive 1 turns counterclockwise		
6	Direction CW 2	BOOL	R/W	TRUE = RollerDrive 2 turns clockwise FALSE = RollerDrive 1 turns counterclockwise		
7	Direction CW 3	BOOL	R/W	TRUE = RollerDrive 3 turns clockwise FALSE = RollerDrive 1 turns counterclockwise		
8	Direction CW 4	BOOL	R/W	TRUE = RollerDrive 4 turns clockwise FALSE = RollerDrive 1 turns counterclockwise		
9	Diameter 1 [mm]	UINT	R/W	Roller diameter RollerDrive 1	30	100
A	Diameter 2 [mm]	UINT	R/W	Roller diameter RollerDrive 2	30	100
B	Diameter 3 [mm]	UINT	R/W	Roller diameter RollerDrive 3	30	100
C	Diameter 4 [mm]	UINT	R/W	Roller diameter RollerDrive 4	30	100
D	Gearing 1	UINT	R/W	Gear ratio RollerDrive 1 e.g. value = 16 for gear box 16:1	1	100
E	Gearing 2	UINT	R/W	Gear ratio RollerDrive 2	1	100
F	Gearing 3	UINT	R/W	Gear ratio RollerDrive 3	1	100
10	Gearing 4	UINT	R/W	Gear ratio RollerDrive 4	1	100
11	Speed Normal 1 [mm/s]	UINT	R/W	Main speed RollerDrive 1	100	2000
12	Speed Normal 2 [mm/s]	UINT	R/W	Main speed RollerDrive 2	100	2000
13	Speed Normal 3 [mm/s]	UINT	R/W	Main speed RollerDrive 3	100	2000
14	Speed Normal 4 [mm/s]	UINT	R/W	Main speed RollerDrive 4	100	2000
15	Speed Alternate 1 [mm/s]	UINT	R/W	Alternate speed RollerDrive 1	100	2000
16	Speed Alternate 2 [mm/s]	UINT	R/W	Alternate speed RollerDrive 2	100	2000

Appendix

Subindex	Designation	Data type	Access	Comment	Min.	Max.
17	Speed Alternate 3 [mm/s]	UINT	R/W	Alternate speed RollerDrive 3	100	2000
18	Speed Alternate 4 [mm/s]	UINT	R/W	Alternate speed RollerDrive 4	100	2000
19	Acceleration 1 [mm/s ²]	UINT	R/W	Start ramp RollerDrive 1	0	9999
1A	Acceleration 2 [mm/s ²]	UINT	R/W	Start ramp RollerDrive 2	0	9999
1B	Acceleration 3 [mm/s ²]	UINT	R/W	Start ramp RollerDrive 3	0	9999
1C	Acceleration 4 [mm/s ²]	UINT	R/W	Start ramp RollerDrive 4	0	9999
1D	Deceleration 1 [mm/s ²]	UINT	R/W	Braking ramp RollerDrive 1	0	9999
1E	Deceleration 2 [mm/s ²]	UINT	R/W	Braking ramp RollerDrive 2	0	9999
1F	Deceleration 3 [mm/s ²]	UINT	R/W	Braking ramp RollerDrive 3	0	9999
20	Deceleration 4 [mm/s ²]	UINT	R/W	Braking ramp RollerDrive 4	0	9999

Inputs and outputs

SDO index: 0x4800

Subindex	Designation	Data type	Access	Comment
1	Type PNP Sensor 1	BOOL	R/W	TRUE: PNP sensor; FALSE: NPN sensor
2	Type PNP Sensor 2	BOOL	R/W	TRUE: PNP sensor; FALSE: NPN sensor
3	Type PNP Sensor 3	BOOL	R/W	TRUE: PNP sensor; FALSE: NPN sensor
4	Type PNP Sensor 4	BOOL	R/W	TRUE: PNP sensor; FALSE: NPN sensor
5	Type PNP Aux 1	BOOL	R/W	TRUE: PNP type
6	Type PNP Aux 2	BOOL	R/W	FALSE: NPN type
7	Type PNP Aux 3	BOOL	R/W	Caution: This is also effective when Aux is used as output.
8	Type PNP Aux 4	BOOL	R/W	
9	Polarity Pos Sensor 1	BOOL	R/W	TRUE: Positive Polarity Sensor (physical "1" corresponds to logical "1") FALSE: Negative Polarity Sensor (physical "0" corresponds to logical "1")
A	Polarity Pos Sensor 2	BOOL	R/W	see above
B	Polarity Pos Sensor 3	BOOL	R/W	see above
C	Polarity Pos Sensor 4	BOOL	R/W	see above
D	Polarity Pos Aux 1	BOOL	R/W	see above
S	Polarity Pos Aux 2	BOOL	R/W	see above
F	Polarity Pos Aux 3	BOOL	R/W	see above
10	Polarity Pos Aux 4	BOOL	R/W	see above
11	IO Function Aux 1	USINT	R/W	Function selection for Aux-I/O according to function table
12	IO Function Aux 2	USINT	R/W	
13	IO Function Aux 3	USINT	R/W	
14	IO Function Aux 4	USINT	R/W	

Appendix

LED indicators SDO index: 0x4800

Subindex	Designation	Data type	Access	Comment
15	IO Diagnose LED On	BOOL	R/W	TRUE: LED on FALSE: LED off

Application module SDO index: 0x4900

Subindex	Designation	Data type	Access	Comment
1	State Table ID	UINT	R/W	
2	Timer 1	UINT	R/W	I/O device application program: Without effect
3	Timer 2	UINT	R/W	Other application programs: Setting according to description
4	Timer 3	UINT	R/W	
5	Timer 4	UINT	R/W	

Appendix

Error behavior SDO index: 0x4A00

Subindex	Designation	Data type	Access	Comment
1	Bus Error Handling	USINT	R/W	Error behavior for bus errors 1 = Ignore: Error is ignored. 2 = Warning: Error is indicated via LEDs and logged. 3 = Minor Error: Motor is stopped immediately (I/O device) or motor is stopped within a logic program (other application program). 4 = Severe Error: Motor is stopped immediately.
2	Over Voltage Error Handling	USINT	R/W	Behavior for over voltage Values see above
3	Under Voltage Error Handling	USINT	R/W	Behavior for under voltage Values see above
4	RollerDrive Error Handling	USINT	R/W	Behavior for a RollerDrive error Values see above
5	State Table Error Handling	USINT	R/W	I/O device: Without effect
6	Control Program Error 1 Handling	USINT	R/W	Other programs: Effect according to description
7	Control Program Error 2 Handling	USINT	R/W	
8	Control Program Error 3 Handling	USINT	R/W	
9	Control Program Error 4 Handling	USINT	R/W	
A	Control Program Error 5 Handling	USINT	R/W	
B	Control Program Error 6 Handling	USINT	R/W	
C	Control Program Error 7 Handling	USINT	R/W	
D	Control Program Error 8 Handling	USINT	R/W	

Appendix

I/O configuration

No.	Value	Designation	Comment
1	0	None	I/O not used
2	1	PLC Input	Input signal to PLC
3	2	PLC Output	Output signal from PLC
4	15	Sensor 5	Additional inputs can also be found at the corresponding point in the process image.
5	16	Sensor 6	
6	17	Sensor 7	
7	18	Sensor 8	
8	21	Control Input 1	
9	22	Control Input 2	
10	23	Control Input 3	
11	24	Control Input 4	
12	25	Control Input 5	
13	26	Control Input 6	
14	27	Control Input 7	
15	28	Control Input 8	
16	31	Control Output 1	
17	32	Control Output 2	
18	33	Control Output 3	
19	34	Control Output 4	
20	35	Control Output 5	
21	37	Control Output 6	
22	38	Control Output 7	
23	41	Control Output 8	
24	42	Handshake InUp	
25	43	Handshake InDown	
26	44	Handshake InSide 1	
27	45	Handshake InSide 2	
28	46	Handshake OutUp	
29	47	Handshake OutDown	
30	48	Handshake OutSide 1	
31	51	Handshake OutSide 2	
32	52	StartGlobalDirect	
33	52	StartGlobalInvers	
34	54	StopGlobalDirect	

Appendix

No.	Value	Designation	Comment
35	55	StopGlobalZpa	
36	56	AlternateSpeedGlobal	
37	57	InverseDirectnGlobal	
38	61	ErrorOutGlobal	
39	62	VDCErrorIn 1	
40	63	VDCErrorIn 2	
41	64	VDCDirectionOut 1	
42	65	VDCDirectionOut 2	
43	66	VDCStepPulseOut 1	
44	67	VDCStepPulseOut 2	

Error codes

No.	Short text	Comment
0	ApplErrNone	No application error, OK
1	ApplErrUnk	Unknown application error
2	ApplErrSystemSevere	Severe system error
3	ApplErrSystemMinor	Minor system error
4	ApplErrSystemWarning	Warning system error
5	ApplErrItemNotFound	A searched item was not found
6	ApplErrRange	Number out of valid range
10	ApplErrNoTerminalInput	SPF terminal has no input data
11	ApplErrStopByOperator	SPF terminal session aborted
12	ApplErrParamIll	Invalid parameter or input
13	ApplErrModuleInit	Module initialization failed
14	ApplErrBufferOverflow	Buffer overflow
20	ApplErrInvalidBusConf	Invalid bus configuration
21	ApplErrBusCom	Bus communication error
22	ApplErrBusStartUp	Bus startup after system (re)start
30	ApplErrErrorDataUpdate	Error updating error data file
31	ApplErrErrorLogUpdate	Error updating error log file
40	ApplErrPanelIllMode	Change of panel mode not allowed
41	ApplErrPanelLedBlocked	Panel not in mode to set LED
42	ApplErrInvalidApplConf	Invalid application configuration
50	ApplErrDriveError1	RollerDrive error drive #1
51	ApplErrDriveError2	RollerDrive error drive #2

Appendix

No.	Short text	Comment
52	ApplErrDriveError3	RollerDrive error drive #3
53	ApplErrDriveError4	RollerDrive error drive #4
60	ApplErrStateTable	State Table entered error state
61	ApplErrCtrlError1	State machine error #1
62	ApplErrCtrlError2	State machine error #2
63	ApplErrCtrlError3	State machine error #3
64	ApplErrCtrlError4	State machine error #4
65	ApplErrCtrlError5	State machine error #5
66	ApplErrCtrlError6	State machine error #6
67	ApplErrCtrlError7	State machine error #7
68	ApplErrCtrlError8	State machine error #8
69	ApplErrStartProgram	Start of state machine impossible
90	ApplErrTemperature	Controller to hot (brake resistor)
91	ApplErrLowVoltage	Supply voltage to low
92	ApplErrHighVoltage	Supply voltage to high
93	ApplErrMotorVoltage	No motor supply voltage
94	ApplErrOvcOverloaded	Brake resistor overloaded
101	ApplErrInvalidStateTblConf	Error loading State Table
102	ApplErrNewStateTable	New state table loaded
103	ApplErrInvalidErrConf	Invalid application configuration
104	ApplErrInvalidTeachParams	Invalid TeachIn Parameters
105	ApplErrPapSaveConfig	Failed to save neighbor config
106	ApplErrPapReadConfig	Failed to read neighbor config

Appendix

Installation declaration

in accordance with the EC Machinery Directive 2006/42/EC, Appendix II B.

The manufacturer:
Interroll Engineering GmbH
Hoeflerhof 16
D - 42929 Wermelskirchen
Germany

hereby declares with sole responsibility that the product range

- MultiControl

is not a ready-to-use machine as defined by the EC Machinery Directive and, therefore, does not fully comply with the requirements of this directive. The commissioning of these conveyor modules is not permitted unless conformity of the entire machine/system in which they are installed has been declared in compliance with the EC Machinery Directive.

The health and safety requirements as stated in Appendix I have been applied. The special technical documents mentioned in Appendix VII B have been prepared and will be sent to the responsible authority if necessary.

Person authorized to prepare the technical documents:
Interroll Engineering GmbH, Hoeflerhof 16, D - 42929 Wermelskirchen, Germany

Applicable EC directives:

- Machinery Directive 2006/42/EC
- EMC Directive 2004/108/EC
- RoHS Directive 2002/95/EC

Applicable harmonized standards:

- DIN EN ISO 12100:2011-03 "Safety of machinery - Basic concepts - risk assessment and reduction"

Wermelskirchen – May 01, 2015

Armin Lindholm
(Managing Director)

(This installation declaration can be obtained at www.interroll.com, if needed.)



